

DIN-A-MITE[®] Power Controllers



heaters | sensors | controllers

AN INNOVATIVE ALTERNATIVE TO INDUSTRY STANDARDS

TOTAL ENGINEERED PACKAGE

The DIN-A-MITE® family of power controllers from Watlow® includes SCR control, heat sink, wiring and a touch-safe exterior all in one package. By designing the DIN-A-MITE as a total unit, we've eliminated the need to prep wires for terminals, find the heat sink for rated amperage and determine adequate terminations. Watlow's DIN-A-MITE is a complete package you can install and forget — everything is already done for you.

In this one package, you'll get:

- Simplicity, easy, fast installation
- Minimal preparation time
- No component selection — you won't have to buy separate parts and worry if they will work
- Minimal engineering involved — you get a complete package, a finished product
- Safety with a touch-safe exterior
- A more compact product than other solid state alternatives for space and cost savings
- A good replacement for mercury displacement relay (MDR)

EASY, FAST INSTALLATION

Since all components are selected and assembled for you, installation is simple and easy, saving time and money. All you have to do is strip wires and connect. You've never installed a power controller easier, or faster.

- No drill and tap necessary
- Back panel or DIN-rail mounted
- Simple, safe wiring
- Similar footprint as MDRs for fast, efficient retrofits

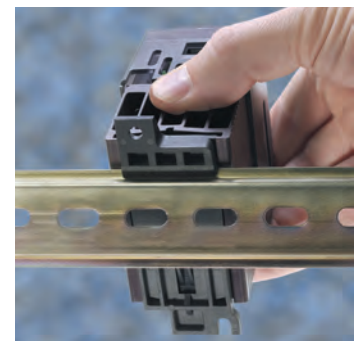
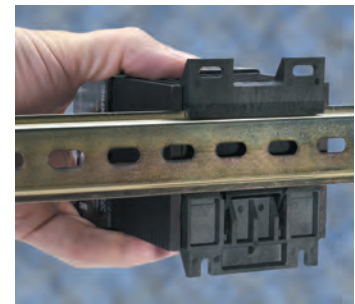

SAFE TO HANDLE

The DIN-A-MITE's touch-safe exterior protects hands from electric shock. It's completely safe to handle.

Power In
Your Hands

AGENCY APPROVED

- UL® 508 listed
- C-UL® approved
- 3-year warranty
- CE

EXTEND THE LIFE OF YOUR HEATERS

ACHIEVE OPTIMUM CONTROL WITH ZERO CROSS SWITCHING

Zero cross switching extends life of the power controller and heater by switching fast, and providing more accurate control of both the heater element and the process. With this improved control, you'll also see an increase in parts produced and less scrap, for improved productivity and efficiency.

- Accurate control
- Improve productivity



REDUCE WEAR ON THERMAL SYSTEM

With optional variable time base switching, the DIN-A-MITE output automatically adjusts cycle time to meet the demands of the system. You'll see benefits such as:

- Less power required by the thermal system
- Heater output equal to need



SYSTEM FAILURE PREVENTION

A proven high current connection scheme ensures optimum electrical connection to prevent heat buildup, which could lead to system failure.



To ensure overall reliability and reduce fear of hot spots, we've eliminated wires and fasteners which could possibly break down and loosen, as with other power controllers.

- Prevent heat buildup
- Improve reliability

PROTECTION FOR YOUR SYSTEM

Zero cross switching produces minimal RFI (radio frequency interference) to help prevent electrical noise that could possibly interfere with other equipment in your system. This added protection for your entire thermal system provides you with less total system downtime and less maintenance for your system.

- Eliminate downtime
- Reduce system maintenance



SET POINT DEVIATION CAUSED BY SWITCH TYPE

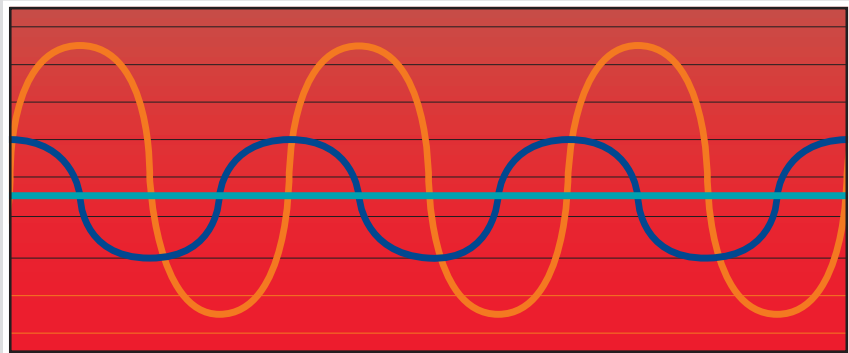

- Mechanical contactors suffer wide temperature deviations due to long cycle time.
- MDRs can be switched faster than contactors, but still deviate considerably from set point.
- DIN-A-MITEs eliminate deviation, providing optimum control and long heater life.

Heaters switched using mechanical contactors suffer wide deviations due to long cycle times—typically 30 seconds—needed to preserve life. Control is poor, heat is wasted, and excessive expansion and contraction of the heating elements shortens heater life. MDRs can be switched faster than contactors and will hold the heater closer to set point, but still suffer deviations.

Fastest of all are solid state devices such as the DIN-A-MITE configured with variable time base. Switching as fast as three ac wave cycles (less than 0.1 seconds), set point deviation is virtually eliminated, giving the finest control, lowest power consumption, and longest element life.

RUGGED, BACK-TO-BACK SCR DESIGN ENSURES LONG TERM RELIABILITY

The DIN-A-MITE meets high current application requirements, tolerates spikes and dissipates less power. When used properly, the DIN-A-MITE outlasts any other type of switch. There's no limit on the number of cycles the DIN-A-MITE can handle.



EASY AS A, B, C OR D, WATLOW HAS A DIN-A-MITE FOR YOUR APPLICATION

OVENS AND FURNACES

In a coatings application, the customer needed to rebuild an oven to improve heater life and temperature control, plus reduce electrical noise. They needed a product that would fit in the existing cabinet to avoid the costs involved with increasing the size of the cabinet. The customer replaced all of the 100 amp mechanical contactors with Watlow's 100 amp DIN-A-MITE SCR power controllers. This customer was able to use the existing control panel and mount the DIN-A-MITE controllers in less space than the mechanical contactors. Additionally, the DIN-A-MITEs provided on-board current transformers as well as built-in semiconductor fusing. These controllers improved heater life and process temperature control while reducing electrical noise with zero cross firing.

SEMICONDUCTOR

Watlow knows the importance of controlling temperature in the semiconductor manufacturing process. Even the slightest variation can cause damage to expensive ingots and chips.

Watlow's variable time base DIN-A-MITE controllers help to maintain process set point without any overshoot or droop variations in temperature, ensuring a quality process. The small size of the DIN-A-MITE means the size of clean room control panels will be minimal, thus saving money.

- Saves valuable space to increase flexibility in semiconductor processing
- Minimal RFI to ensure long life of the heaters and other system equipment

PLASTICS

In plastics processing, Watlow's DIN-A-MITE is an ideal replacement for MDRs in injection molding, extrusion, blown film extrusion and blow molding systems. You'll get better control of the heater and the process, more accurate temperatures, a more consistent product, less rejects and reduced downtime.

A plastics manufacturer used MDRs in their equipment, but wanted longer heater life that relays could not provide. They were also encountering some trouble with machines occasionally shutting down. Watlow recommended three-phase, two leg DIN-A-MITE controllers to replace the MDRs. The DIN-A-MITEs fit in the same footprint as the relays, so there was no need to reconfigure the machine to accept the new controllers. The DIN-A-MITEs also eliminated electrical noise and prevented machine stoppages, therefore reducing downtime.

DIN-A-MITE FAMILY APPLICATIONS:

- Food Equipment
- Life science/medical
- Ovens/Furnaces
- Packaging
- Petroleum/Chemical
- Plastics
- Semiconductor
- Wave Solder and Reflow

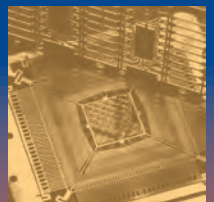

Look inside pocket for complete technical specifications of Watlow's DIN-A-MITE power controllers.



MERCURY FREE



A Retrofit for MDRs

Because the disposal of mercury is a significant environmental issue, Watlow encourages you to consider the use of the DIN-A-MITE family of power controllers instead of mercury displacement relays (MDR).

We designed the DIN-A-MITE to a similar size, amperage specification, and footprint as MDRs. So, if eliminating mercury from your equipment is a concern, you'll eliminate mercury and receive a controller, with even more features and advantages.

Compact Solid State Power Controller Delivers Big Performance

The Watlow® DIN-A-MITE® Style A power controller provides a low-cost, highly compact and versatile solid state option for controlling electric heat. You also get all the quality you expect from a Watlow designed and manufactured product. DIN-rail and back panel mounting is standard on every controller. There is no need to worry about mercury, the DIN-A-MITE controller is mercury free.

Capabilities include single-phase zero cross switching up to 25 amps at 600V~(ac) (see rating curve). A unique integrated design removes the guesswork associated with selecting a proper heat sink and adequate terminations for the application.

Variable time base, 4-20mA process control or V~(ac/dc) input contactor versions are available. All configurations are model number dependent and factory selectable. This power controller also includes 200KA short circuit current rating (SCCR) tested up to 480V~(ac) to prevent arch flash with required fusing.



Features and Benefits

200KA Short Circuit Current Rating (SCCR)

- Prevents arc flash

DIN-rail or standard panel mount

- Versatile, quick and low-cost installation

Compact size

- Reduces panel space; less cost

Touch-safe terminals

- Increases safety for installer/user

No mercury

- Environmentally safe product

Faster switching with solid state

- Saves energy and extends heater life

UL® 508 listed, C-UL® and CE with filter

- Meets applications requiring agency approval

Back-to-back SCR design

- Insures a rugged design

New Feature

Specifications

Operator Interface

- Command signal input
- Input indicator light LED

Amperage

- Single phase, see the output rating curve
- Max. I²t for fusing: 4000A²sec
- Latching current: 200mA
- Holding current: 100mA
- Power dissipation is 1.2 watts per amp switched
- 200KA SCCR, Type 1 and 2 approved with the recommended fusing; see user manual.

Line Voltage

- 20 to 660V~(ac) model number dependent; see ordering information
- Off-state leakage: 1mA at 77°F (25°C) max.
- 50/60Hz independent

Control Mode-Zero Cross

- Input control signal Type C: V=(dc) input contactor
- Input control signal Type K: V~(ac) input contactor
- To increase service life on contactor input models, the cycle time should be less than three seconds
- Input Control Signal Type F: 4 to 20mA=(dc) proportional variable time base control; 3 cycles on, 3 cycles off at 50% power

Input Command Signal

- AC contactor
24V~(ac) ±10%, 120V~(ac) +10/-25%, 240V~(ac) +10/-25% @ 25mA max. per controlled leg
- DC Contactor
4.5V= to 32V=(dc): max. current @ 4.5 V=(dc) is 8mA per leg
- Loop powered linear current
4mA= to 20mA=(dc): loop-powered, input Type F0 option only (requires current source with 6.2V=(dc) available, no more than three DIN-A-MITE inputs can be connected in series)

Agency Approvals

- UL® 508-listed and C-UL® File E73741
- CE with proper filter:
89/336/EEC Electromagnetic Compatibility Directive
73/23/EEC Low Voltage Directive
EN 61326 Industrial Immunity Class A Emissions
EN 50178 Safety Requirements

Input Terminals

- Compression: will accept 0.2 to 2 mm² (24 to 14 AWG) wire

Line and Load Terminals

- Compression: will accept 0.8 to 8.4 mm² (18 to 8 AWG) wire

Operating Environment

- Up to 176°F (80°C); see the output rating curve chart for your application
- 0 to 90% RH (relative humidity), non-condensing
- Installation only tested to 3,000 meters
- Units are suitable for "Pollution degree 2"

Mounting

- Options include DIN-rail or standard back panel mounting
- The DIN-rail specification is: DIN EN 50022, 35 mm by 7.5 mm
- Mount the cooling fins vertically

Dimensions

- Height: 3.7 in. (95 mm) high x 1.8 in. (45 mm) wide x 3.9 in. (98 mm) deep
- Weight: 0.71 lb (0.32kg)

Specifications are subject to change without notice.

Ordering Information

To order, complete the code number on the right with the information below.

DIN-A-MITE Style A = Solid State Power Controller

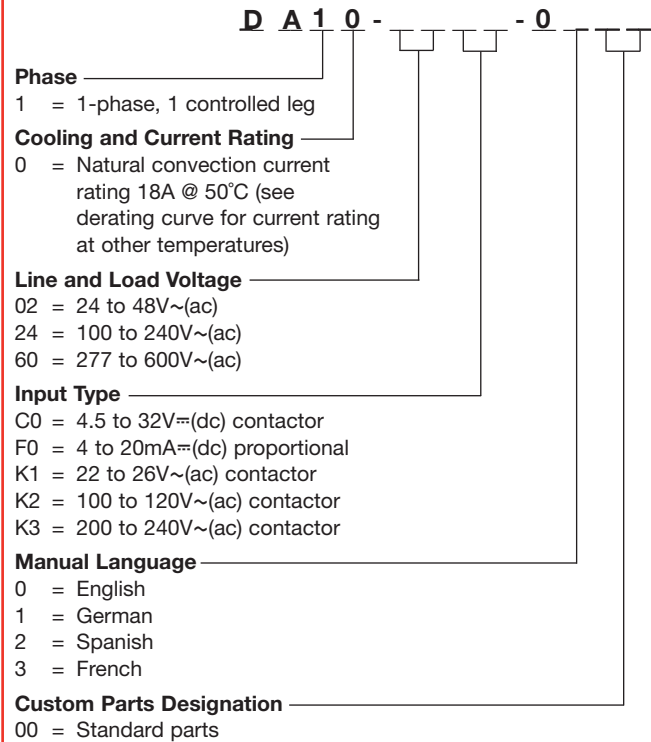

Recommended Semiconductor Fuse and Fuse Holder

	Watlow	Cooper Bussmann®	Ferraz Shawmut
Fuse	17-8025	FWC25A10F	L330014
Holder	17-5110	B24202	G81219

Output Rating Curve

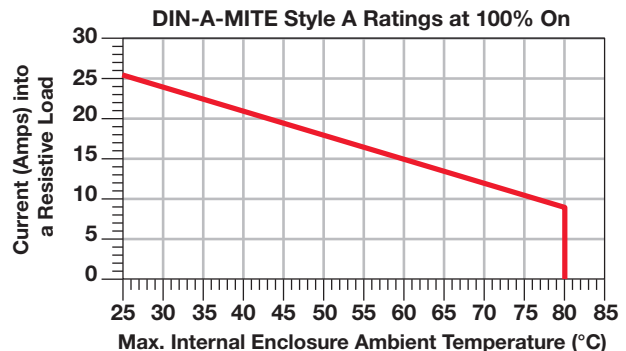

Single- and Three-Phase Power in a Compact and Safe Package

The Watlow® DIN-A-MITE® Style B power controller provides a low-cost, highly compact and versatile solid state option for controlling electric heat. You also get all the quality you expect from a Watlow designed and manufactured product. DIN-rail and back panel mounting are standard on every control. There is no need to worry about mercury, the DIN-A-MITE controller is mercury free.

Capabilities include single-phase and three-phase zero cross switching up to 40 and 22 amps, respectively, at 600V~(ac) (see rating curve). A unique, integrated design removes the guesswork associated with selecting a proper heat sink and adequate terminations for the application.

Variable time base, 4-20mA process control or V~(ac/dc) input contactor versions are available. A shorted Silicon Controlled Rectifier (SCR) alarm option is also available. All configurations are model number dependent and factory selectable. This power controller also includes 200KA short circuit current rating (SCCR) tested up to 480V~(ac) to prevent arch flash with required fusing.



TOTAL
CUSTOMER
SATISFACTION
3 Year Warranty

Features and Benefits

200KA Short Circuit Current Rating (SCCR)

- Prevents arc flash

DIN-rail or standard panel mount

- Versatile, quick and low-cost installation

Compact size

- Reduces panel space; less cost

Touch-safe terminals

- Increases safety for installer/user

Single- and three-phase power

- Permits use in a variety of applications

No mercury

- Environmentally safe product

Faster switching with solid state

- Saves energy and extends heater life

UL® 508 listed, C-UL® and CE with filter

- Meets applications requiring agency approval

Back-to-back SCR design

- Insures a rugged design

Shorted output alarm (optional)

- Notifies you in case of a shorted SCR

New
Feature

Specifications

Operator Interface

- Command signal input and indication light
- Alarm output and indication light

Amperage Rating

- See the output rating curve
- Max. surge current for 16.6ms, 380A peak
- Max. I²t for fusing is 4,000A²s
- Latching current: 200mA min.
- Holding current: 100mA min.
- Off-state leakage 1mA at 77°F (25°C) max.
- Power dissipation = 1.2 watts per amp per leg switched
- 200KA SCCR, Type 1 and 2 approved with the recommended fusing; see user manual.

Line Voltage

- 20 to 660V~(ac) model number dependent; see ordering information

Control Mode, Zero-Cross

- Input control signal Type C: V=(dc) input contactor
- Input control signal Type K: V~(ac) input contactor
- To increase service life on contactor input models the cycle time should be less than three seconds
- Input Control Signal Type F: 4 to 20mA=(dc) proportional variable time base control

Input Command Signal

- AC contactor
 - 24V~(ac) ±10%, 120V~(ac) +10/-25%, 240V~(ac) +10/-25% @ 25mA max. per controlled leg
- DC Contactor
 - 4.5 to 32V=(dc): max. current @ 4.5V=(dc) is 6mA per leg. Add 2mA per LED used to the total current
- Loop powered linear current
 - 4 to 20mA=(dc): loop-powered, input Type F0 option only (requires current source with 6.2V=(dc) available, no more than three DIN-A-MITE inputs connected in series); 3 cycles on, 3 cycles off at 50% power

Alarm

Shorted SCR Alarm Option

- Alarm state when the input command signal off and a 10A or more load current is detected by the current transformer (two turns required for 5A and three turns for 2.5A)

Alarm Output

- Energizes on alarm, non-latching
- Triac 24 to 240V~(ac), external supply with a current rating of 300mA @ 77°F (25°C), 200mA @ 122°F (50°C), 100mA @ 176°F (80°C) and a holding current of 200 µA with a latching current of 5mA typical

Agency Approvals

- CE with proper filter:
 - 89/336/EEC Electromagnetic Compatibility Directive
 - EN 61326: Industrial Immunity Class A emissions
- 73/23/EEC Low Voltage Directive
 - EN 50178 Safety Requirements

Installation category III, pollution degree 2

-  UL® 508 listed and C-UL® File E73741

Input Terminals

- Compression: will accept 0.2. to 2 mm² (24 to 14 AWG) wire

Line and Load Terminals

- Compression: will accept 0.8 to 8.4 mm² (18 to 8 AWG) wire

Operating Environment

- See the output rating curve
- 0 to 90% RH (relative humidity), non-condensing
- Storage temperature: -40 to 185°F (-40 to +85°C)
- Insulation only tested to 3,000 meters

DIN-rail Mount

- DIN EN 50022, 35 mm by 7.5 mm

Back Panel Mount

- Four mounting holes M3 to M4 (No. 6 to No. 8) fastener

Dimensions

- Height: 3.7 in. (95 mm) high x 3.1 in. (80 mm) wide x 4.9 in. (124 mm) deep
- Weight: 1.5 lb (0.68kg)

Specifications are subject to change without notice.

Ordering Information

To order, complete the code number on the right with the information below.

DIN-A-MITE Style B = Solid State Power Controller

Phase	D	B	-	-	-
1 = 1-phase, 1 controlled leg					
2 = 3-phase, 2 controlled legs					
3 = 3-phase, 3 controlled legs					
8 = 2 independent zones (input control C or K)					
9 = 3 independent zones (input control C or K)					
Cooling and Current Rating Per Pole					
0 = Natural convection standard DIN-rail or panel mount heat sink					
Line and Load Voltage					
02 = 24 to 48V~(ac)					
24 = 120 to 240V~(ac)					
60 = 277 to 600V~(ac)					
Input Control Signal					
C0 = 4.5 to 32V=(dc) contactor					
F0 = 4 to 20mA=(dc) proportional					
K1 = 22 to 26V~(ac) contactor					
K2 = 100 to 120V~(ac) contactor					
K3 = 200 to 240V~(ac) contactor					
Alarm					
0 = No alarm					
S = Shorted SCR alarm					
User Manual					
0 = English					
1 = German					
2 = Spanish					
3 = French					
Custom Part Numbers					
00 = Standard part					
XX = Any letter or number, custom options, labeling, etc.					

Recommended Semiconductor Fuse and Fuse Holders

Fuse Rating	Watlow	Cooper Bussmann®	Ferraz Shawmut
20A	17-8020	FWC20A10F	K330013
25A	17-8025	FWC25A10F	L330014
40A	17-8040	FWC40A14F	A093909
50A	17-8050	FWC50A14F	B093910

Fuse Rating	Watlow	Cooper Bussmann®	Ferraz Shawmut
20A	17-5110	CHM1G	G81219
25A	17-5110	CHM1G	G81219
40A	17-5114	CH141G	J081221
50A	17-5114	CH141G	J081221

Output Rating Curve

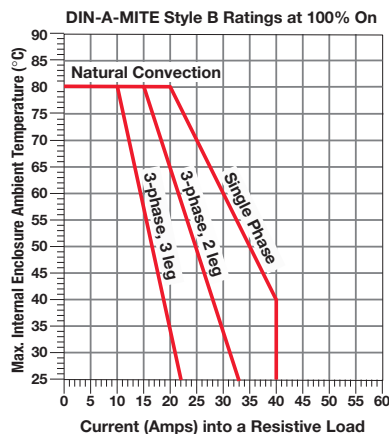

Current Rating Table

Phase	Cooling	Current at 122°F (50°C)
1	0	35A
2, 8	0	25A
3, 9	0	17A

SCR Power Controller Delivers Up To 80 Amps in a Compact Package

The Watlow® DIN-A-MITE® Style C SCR power controller provides you with a low cost, compact and versatile solid state option for controlling electric heat. You also get all the quality you expect from a Watlow designed and manufactured product. DIN-rail and standard panel mounting plus a cabinet thru-wall mount version is available.

Basic features include single-phase, three-phase/two leg, and three-phase/three leg, 24-600V~(ac) operation. Current switching capabilities range from 30 to 80A depending on the model ordered.

Variable time base, linear voltage and current process control or $V\approx(ac/dc)$ input contactor versions are available. Also single-phase, phase angle firing and current limiting are available. All configurations are model number dependent and factory selectable. This power controller also includes 200KA short circuit current rating (SCCR) tested up to 480V~(ac) to prevent arch flash with required fusing.



Features and Benefits

200KA Short Circuit Current Rating (SCCR)

- Prevents arc flash

DIN-rail and standard panel mount thru-wall mounting

- Versatile, quick and low-cost installation

Compact size

- Reduces panel space; less cost

Touch-safe terminals

- Increases safety for installer/user

One- and three-phase power

- Can be used in a variety of applications

Open heater/shorted output alarm

- Notifies you in case of an open heater or shorted output

No mercury

- Environmentally safe

Faster switching with solid state

- Saves energy and extends heater life

UL® 508 listed, C-UL® and CE with filter

- Meets applications requiring agency approval

System solution component

- Provides single source thermal loop

Back-to-back SCR design

- Insures a rugged design

New Feature

Specifications

Operator Interface

- Command signal input and indication light
- Alarm output and indication light
- Current limit indication LED

Amperage Rating

- See output rating curves on page 3
- Max. surge current for 16.6ms, 1,350A peak
- Max. I²t for fusing is 9100A²s
- Latching current: 200mA min.
- Holding current: 100mA min.
- Fan current: 0.14A for 24V~(dc); 0.12A for 120V~(ac); 0.06A for 240V~(ac)
- Off-state leakage 1mA at 77°F (25°C) max.
- Power dissipation: 1 watt per amp per leg switched
- 200KA SCCR, Type 1 and 2 approved with the recommended fusing; see user manual

Line Voltage

- 24 to 48V~(ac) units: 20.4V~(ac) min. to 53V~(ac) max.
- 100 to 240V~(ac) units: 48V~(ac) min. to 265V~(ac) max.
- 277 to 600V~(ac) units: 85V~(ac) min. to 660V~(ac) max.
- 100 to 120V~(ac), 200 to 208V~(ac), 230 to 240V~(ac), 277V~(ac), 400V~(ac), 480V~(ac), 600V~(ac), +10/-15%, 50 to 60Hz independent ±5% (Input control signal Type L, P and S)

Alarms (zero cross models only)

Shorted SCR Alarm Option

- Alarm state when the input command signal is off and a 10A or more load current is detected by the current transformer (two turns required for 5A or three turns for 2.5A)

Open Heater Alarm Option (Input Control Signal Type S only)

- Alarm state when the input command signal is on and the load current detected by the current transformer is 20% less than customer adjusted set point

Alarm output

- Energizes on alarm, non-latching
- Triac 24 to 240V~(ac), external supply with a current rating of 300mA @ 77°F (25°C), 200mA @ 122°F (50°C), 100mA @ 176°F (80°C) and a holding current of 200 µA with a latching current of 5mA typical

Agency Approvals

- CE with proper filter:
89/336/EEC Electromagnetic Compatibility Directive
EN 61326: Industrial Immunity Class A emissions not suitable for Class B environments
73/23/EEC Low Voltage Directive EN 50178 Safety Requirements Installation category III, Pollution degree 2
Phase angle and phase angle with current limit input control signal Types (P and L) are not CE approved
- UL® 50 Type 4X Enclosure and UL® 1604 File E184390 (ANSI/ISA 12.12.01)
(Thru-wall heat sink mounting only)
-  UL® 508 listed and C-UL® File E73741
- Shock and vibration tested to IEC 60068-2-32
- Vibration tested to IEC 60068-2-6

Input Terminals

- Compression: will accept 0.2 to 1.5 mm² (24 to 16 AWG) wire
- Torque to 0.5 Nm (4.4 in. lb) max. with a 1/8 in. (3.5 mm) blade screwdriver

Line and Load Terminals

- Compression: will accept 2 to 21 mm² (14 to 4 AWG) wire
- Torque to 2.7 Nm (24 in. lb) max. with a 1/4 in. (6.4 mm) blade screwdriver, or a type 1A, #2 Pozi driver

Operating Environment

- See the output rating curve chart on page 3
- 0 to 90% RH (relative humidity), non-condensing
- Storage temperature: -40 to 185°F (-40 to +85°C)
- Insulation only tested to 3,000 meters

DIN-Rail Mount

- DIN EN 50022, 35 mm by 7.5 mm

Back Panel Mount

- Four mounting holes M3 to M4 (No. 6 to No. 8) fastener

Through-Wall Mount

- See page 4 for thru-wall panel cutout

Note: Mount cooling fins vertically

Additional Specifications for Contactors and Proportional Controllers

Control Mode, Zero-Cross

- Input control signal Type C: V~(dc) input contactor
- Input control signal Type K: V~(ac) input contactor
- To increase service life on contactor input models the cycle time should be less than three seconds
- Input control signal Type F: 4 to 20mA~(dc) proportional variable time base control

Input Command Signal

- AC contactor
24V~(ac) ±10%, 120V~(ac) +10/-25%, 240V~(ac) +10/-25% @ 25mA max. per controlled leg
- DC contactor
4.5 to 32V~(dc): max. current @ 4.5V~(dc) is 6mA per leg. Add 2mA per LED used to the total current
- Loop powered linear current
4 to 20mA~(dc): loop-powered, input Type F0 option only, no more than three inputs connected in series. See page 5 for detail operation.

Additional Specifications for Phase Angle, Phase Angle Current Limit and Single Cycle VTB

Operation

- Burst firing (zero-cross) control, single-cycle variable time base, Type S single phase and 3-phase. Unit is not on for more than one full cycle under 50% power and not off for more than one full cycle above 50% power
- Phase angle control, single-phase only

Input Command Signal

- 0 to 20mA, 4 to 20mA, 0 to 5V_{DC}, 1 to 5V_{DC} and 0 to 10V_{DC}
- Input impedance 250Ω for 4mA to 20mA, 5kΩ for linear voltage input

Output Voltage

- 100 to 120V_{AC}, 200 to 208V_{AC}, 230 to 240V_{AC}, 277V_{AC}, 400V_{AC}, 480V_{AC} and 600V_{AC}, ±10%

Linearity (Input Control Signal Type S)

- ±5% input to output power over 0 to 100% of span between calibration points

Linearity (Phase Angle Input Control Type P and L)

- ±5% input to output power, as referenced to a sinusoidal power curve, between calibration points

Resolution

- Better than 0.1% of input span with respect to output change

Soft Start

(Phase Angle Input Control Signal Type P and L)

Typically:

- 5 seconds soft start on power up
- Soft start on thermostat overtemperature
- Soft start on ½ cycle drop out detection
- 1 second soft start on set point change

Options

- Manual Control Kit (1kΩ potentiometer) 08-5362
- Alarm option is **not** available on phase angle Input Control Signal Type P or L

Specifications are subject to change without notice.

Output Rating Curves

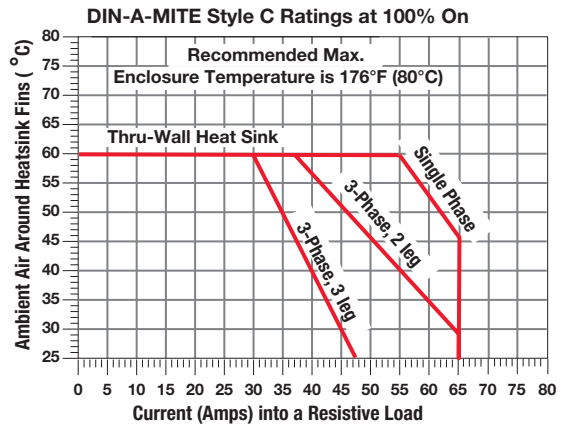
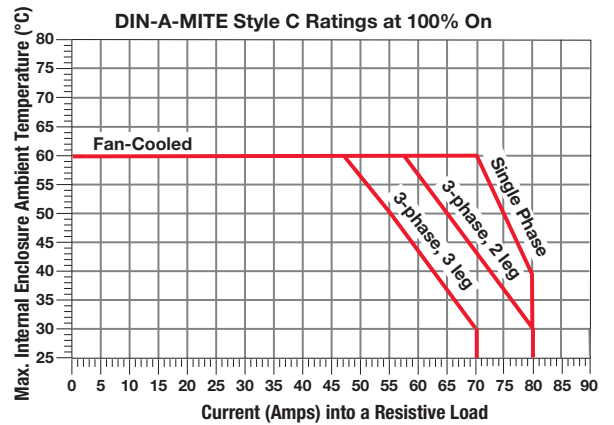
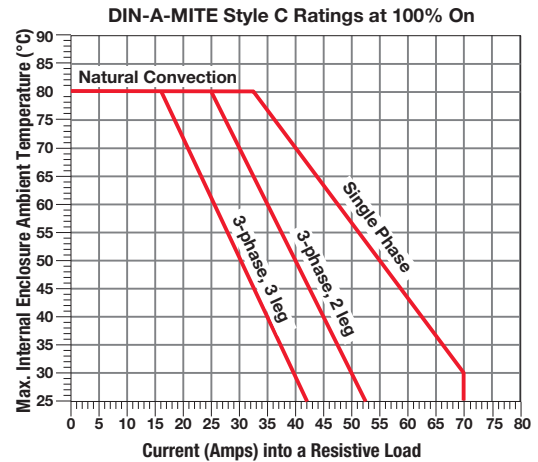

Style C Dimensions Without Cooling Fan

Front

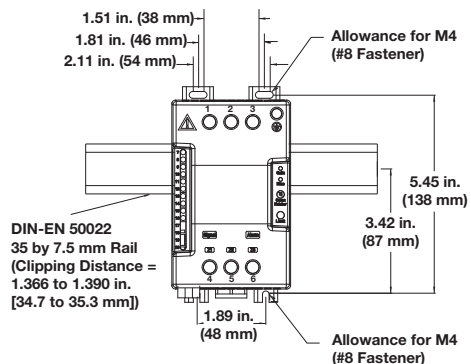

Side

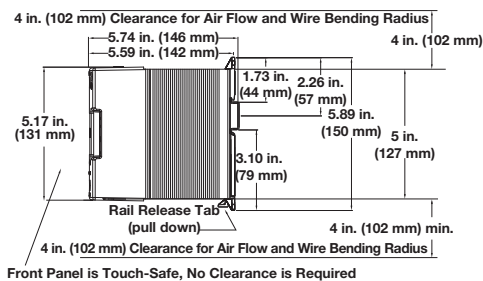

Top

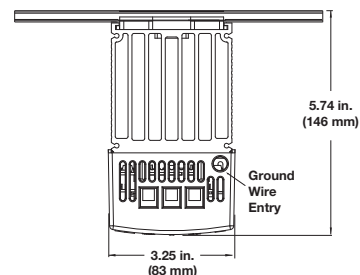

With Cooling Fan

Side

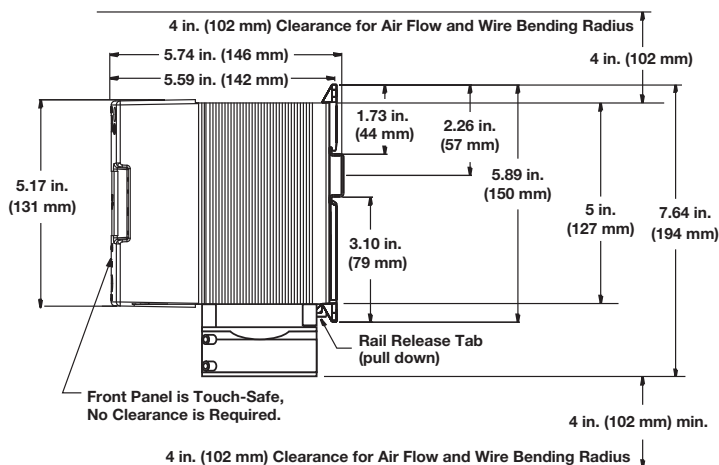

Thru-Wall Style C^①

Front

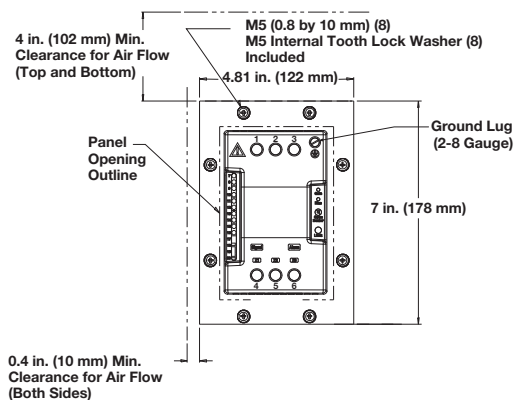

Top

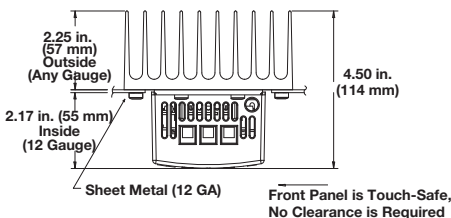

Panel Cutout

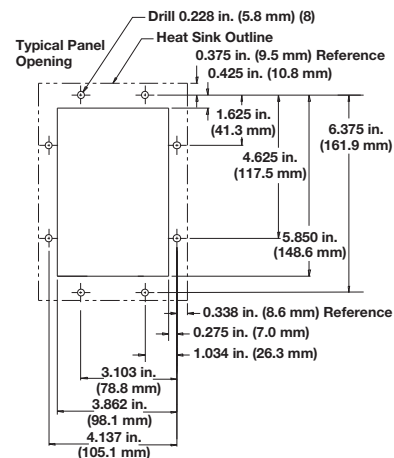

^① With the potential for high thru-wall heat sink temperatures, application may require a touch-safe shield.

Extended Heater And Power Controller Life With Variable Time Base

With variable time base control, the power controller automatically adjusts the time base and output power with respect to process input. Accelerated life testing verified that variable time base control significantly reduces expansion and contraction of the heater element. This extends heater and power controller life while improving process temperature control. You save money on heaters, downtime and maintenance.

Loop Powered or Transformer Powered

Loop Powered

By using a temperature control 4-20mA process output signal as the power supply for the DIN-A-MITE input the cost of the power control can be reduced. With zero cross (burst fired) the 4-20mA input signal simultaneously performs the tasks of providing a power supply and an input command signal. The DIN-A-MITE "FO" input control signal is a loop powered option and will work as single- or three-phase. It works only with a 4-20mA input.

Transformer Powered

Some DIN-A-MITE models require that an on-board power supply be used to power the internal electronics. Phase angle options require that we detect the zero cross of the ac sine wave and thus a transformer is required also. The DIN-A-MITE input control signal types "L", "P" and "S" are transformer powered and can be controlled manually (open loop) with a potentiometer input or in the auto mode (close loop) with a temperature control using any of the 4-20mA, linear voltage (0-5, 1-5 and 0-10V=(dc)) input types.

Loop Powered 4-20mA Variable Time Base

Models: DC__-[02, 24, 60] [FO]-_____

20% Power Output



3~ cycles on, 12~ cycles off

50% Power Output



3~ cycles on, 3~ cycles off

80% Power Output



12~ cycles on, 3~ cycles off

Phase Angle

Models: DC1_ - _ _ [L, P] 0 - 0_ _ _

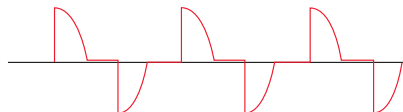

Phase angle (input control type "P") phase control is infinitely variable inside the sine wave. This provides a variable voltage and/or current output. This option includes soft start and line voltage compensation. This is transformer powered and therefore will work with a linear voltage, current input or a potentiometer input. This is single-phase only.

Single Cycle Variable Time Base

Models: DC_ _ _ _ S_ _ _ _ _

25% Power Output

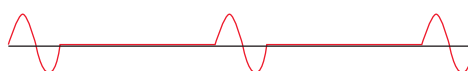

1~ line cycle on, 3 ~ cycles off

50% Power Output

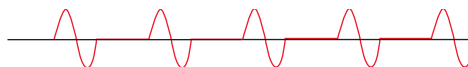

1~ line cycle on, 1 ~ cycle off

With single-cycle variable time base (VTBS) control, at 50% power, power is on one cycle and off one cycle. At 25%, it is on for one cycle and off for three. Under 50%, the unit is not on for more than one consecutive cycle. Over 50%, the unit is not off for more than one consecutive cycle. This model will work with a linear voltage input, a 4 to 20mA input or a potentiometer input.

Recommended Semiconductor Fuse for Applications Through 600V~(ac)

Fuse Rating	Wattlow	Fuse Part Number	
		Cooper Bussman®	Ferraz Shawmut
40A	17-8040	FWP-40A14F	A093909
50A	17-8050	FWP-50A14F	B093910
63A	17-8063	FWP-63A22F	T094823
80A	17-8080	FWP-80A22F	A094829
100A	17-8100	FWP-100A22F	Y094827

Fuse Rating	Wattlow	Fuse Holder Part Number	
		Ferraz Shawmut	
40A	17-5114	US1411	
50A	17-5114	US1411	
63A	17-5122	US2211	
80A	17-5122	US2211	
100A	17-5122	US2211	

Ordering Information

To order, complete the code number on the right with the information below:

Style C = Solid-State Power Controller

D C

Phase

- 1 = 1-phase, 1 controlled leg
- 2 = 3-phase, 2 controlled legs
- 3 = 3-phase, 3 controlled legs, (use with four wire wye)
- 8 = 2 independent zones (Input Type C, K)
- 9 = 3 independent zones (Input Type C, K)

Cooling and Current Rating Per Leg* (see chart below)

- 0 = Natural convection standard DIN-rail or panel heat sink
- 1 = Fan cooled 120V~(ac) standard DIN-rail or panel heat sink
- 2 = Fan cooled 240V~(ac) standard DIN-rail or panel heat sink.
- 3 = Fan cooled 24V~(dc) standard DIN-rail or panel heat sink
- T = Natural convection through wall or cabinet heat sink (NEMA 4X)

Line and Load Voltage

- 02 = 24 to 48V~(ac) (control C, F, K)
- 12 = 100 to 120V~(ac) (control L, P, S)
- 20 = 200 to 208V~(ac) (control L, P, S)
- 24 = 100 to 240V~(ac) (control C, F, K): 230 to 240V~(ac) (control L, P, S)
- 27 = 277V~(ac) (control L, P, S)
- 40 = 400V~(ac) (control L, P, S)
- 48 = 480V~(ac) (control L, P, S)
- 60 = 277 to 600V~(ac) (control C, F, K): 600V~(ac) (control L, P, S)

Input Control Signal

- C0 = 4.5 to 32V~(dc) contactor
- F0 = 4 to 20mA~(dc) proportional
- K1 = 22 to 26V~(ac) contactor
- K2 = 100 to 120V~(ac) contactor
- K3 = 200 to 240V~(ac) contactor
- L (0 to 5) = Phase angle with current limiting^① (single-phase only)
- P (0 to 5) = Phase angle^① (single-phase only)
- S (0 to 5) = Single cycle variable time base
 - 0 = 4 to 20mA
 - 1 = 12 to 20mA (for input control signal option S only)
 - 2 = 0 to 20mA
 - 3 = 0 to 5V~(dc) proportional
 - 4 = 1 to 5V~(dc) proportional
 - 5 = 0 to 10V~(dc) proportional

Alarm

- 0 = No alarm
- S = Shorted SCR alarm (zero cross models only)
- H = Open-heater and shorted-SCR alarm (for input control signal Option S)

Language

- 0 = English
- 1 = German
- 2 = Spanish
- 3 = French

Custom Part Numbers

- 00 = Standard part
- 1X = 1-second soft start (control option P, L)
- XX = Any letter or number, custom options, labeling, etc.

^① Not CE Approved for conducted or radiated emissions.

*DIN-A-MITE C Current Rating Table

Phase	Cooling	Current at 50°C (122°F)
1	0	55A
1	T	60A
1	(1, 2, 3)	75A
2, 8	0	40A
2, 8	T	46A
2, 8	(1, 2, 3)	65A
3, 9	0	30A
3, 9	T	35A
3, 9	(1, 2, 3)	55A

SCR Power Controller Delivers Up To 100 Amps in a Smart Package

The Watlow® DIN-A-MITE® Style D Silicon Controlled Rectifier (SCR) power controller provides you with an inexpensive, versatile product for controlling heat in an efficient package. You also get all the quality you expect from a Watlow designed and manufactured product. The standard back panel mounting footprint is equal to that of an industry standard mercury displacement relay. There is no need to worry about mercury, the DIN-A-MITE controller is mercury free.

The DIN-A-MITE Style D is capable of zero cross switching up to 100 amps single-phase, at 600V~(ac) at 86°F (30°C), depending on the model selected. Combined with the input of two or three controllers and you can control three-phase. It is totally touch-safe and includes standard back panel mounting, on-board semiconductor fuses (accessible from the front) and a current transformer option for external load current monitoring. An optional “shorted SCR detector” feature is available on some models. This model is UL® 508 and C-UL® and CE approved. These agency approvals are ideal for those panel builders that require agency approvals on their panels and cabinets.

Variable time base, 4-20mA process control, or V~(ac/dc) input contactor options are available. All configurations are model number dependent and factory selectable. This power controller also includes 200KA short circuit current rating (SCCR) tested up to 480V~(ac) to prevent arch flash with required fusing.



Features and Benefits

200KA Short Circuit Current Rating (SCCR)

- Prevents arc flash

Standard panel mount

- Provides same mount as industry standard 100A MDR

Compact size

- Reduces panel space; less cost

Touch-safe terminals

- Increases safety for installer/user

No mercury

- Environmentally safe product

Faster switching with solid state

- Saves energy and extends heater life

UL® 508 listed, C-UL® and CE with filter

- Meets applications requiring agency approval

Back-to-back SCR design

- Insures a rugged design

On-board semiconductor fusing

- Provides quick access with no extra mounting necessary



THE DIN-A-MITE® FAMILY

WATLOW®
Better Thermal Solutions...Faster



	DIN-A-MITE Style A	DIN-A-MITE Style B	DIN-A-MITE Style C	DIN-A-MITE Style D
1-Phase ^①	Up to 25A @ 600V~(ac)	Up to 40A @ 600V~(ac)	Up to 80A @ 600V~(ac)	Up to 100A @ 600V~(ac)
3-Phase, 2 leg ^①	No	Up to 33A @ 600V~(ac)	Up to 80A @ 600V~(ac)	Gang 2 units
3-Phase, 3 leg ^①	No	Up to 22A @ 600V~(ac)	Up to 70A @ 600V~(ac)	Gang 3 units
200KA SCCR	Yes	Yes	Yes	Yes
V~(ac) and V=(dc) - Burst Fire Contactor Input	24, 120 & 240V~(ac) 4.5-32V=(dc)	24, 120 & 240V~(ac) 4.5-32V=(dc)	24, 120 & 240V~(ac) 4.5-32V=(dc)	24, 120 & 240V~(ac) 4.5-32V=(dc)
Multizone V~(ac) & V=(dc) Input	No	Yes	Yes	No
4-20mA=(dc) Input - Variable Time Base Output	Yes	Yes	Yes	Yes
Phase Angle Fire Output ^②	No	No	Yes 1-phase only	No
Manual Control Via Potentiometer Input, or 0-5, 1-5 or 0-10V=(dc) Linear Voltage Input	No	No	Yes	No
Shorted SCR Alarm	No	Yes	Yes	Yes
Open Heater Alarm	No	No	Yes With "S" input only	No
Load Current Monitor CT	No	No	No	Yes
On Board Semiconductor Fusing	No	No	No	Yes
DIN-Rail Mount	Yes	Yes	Yes	No
Sub-Panel Mount	Yes	Yes	Yes	Yes
Cabinet Thru-Wall Heat Sink Mount UL® 50 and UL® 1604 (ANSI/ISA 12.12.01)	No	No	Yes	No
Electrically Touch-Safe Package	Yes	Yes	Yes	Yes
Back-to-Back SCR Design	Yes	Yes	Yes	Yes
UL® 508 Listed/C-UL®/CE w/filter	Yes	Yes	Yes ^②	Yes
Dimensions	3.7 H X 1.8 W X 3.9 in. D (95 X 45 X 98 mm)	3.7 H X 3.1 W X 4.9 in. D (95 X 80 X 124 mm)	6.0 H X 3.1 W ^③ X 5.7 in. D (150 X 80 X 146 mm)	7.25 H X 2.5 W X 9.4 in. D (185 X 65 X 240 mm)
Controller Weight: lbs (kg)	0.71 (0.32)	1.5 (0.68)	2.6 (1.18)	6.5 (2.95)
Controller Weight w/fan: lbs (kg)	N/A	N/A	3.2 (1.45)	N/A

^① Refer to curves on reverse side for specific ratings.

^② Phase angle fire, is not CE approved.

^③ Will fit within the width dimension of most comparable MDRs.

Amperage Curves

DIN-A-MITE A

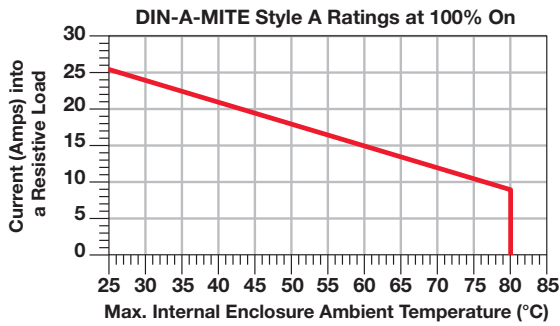

DIN-A-MITE B

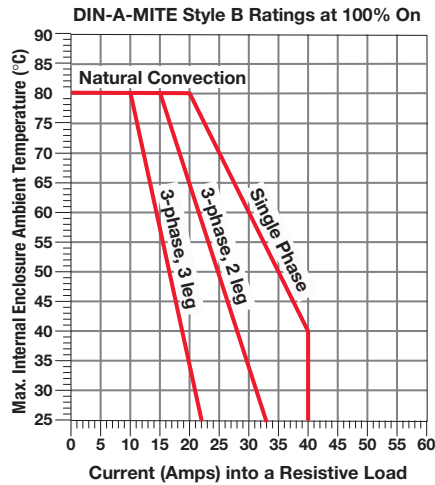

DIN-A-MITE C

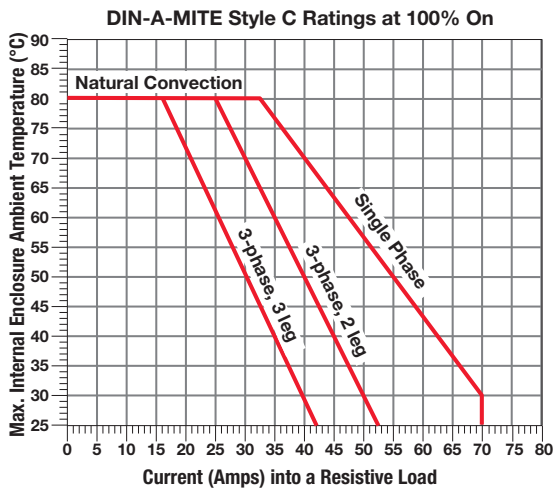

DIN-A-MITE C - Fan Cooled

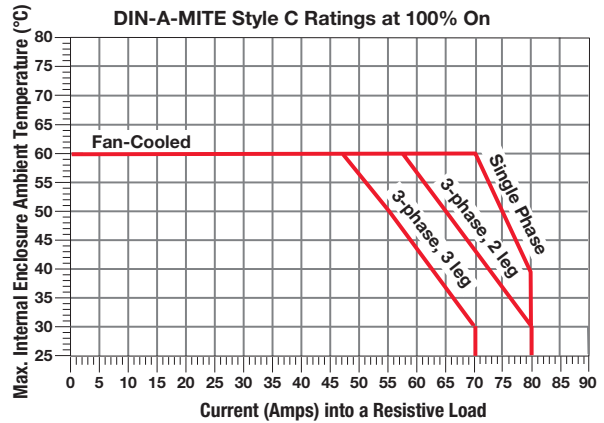

DIN-A-MITE C - Thru-Wall

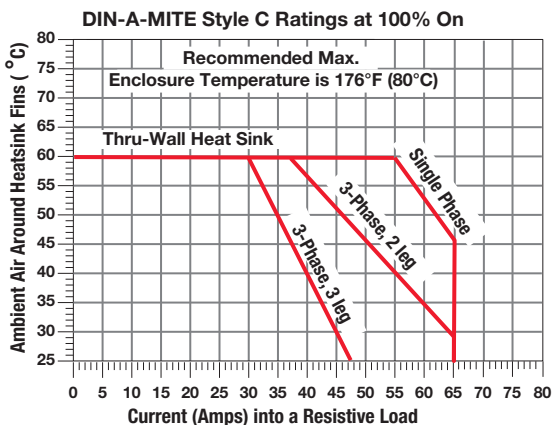

DIN-A-MITE D

